

# How To Install SOLIDWORKS MBD 2022

TITLE:	How To Install SOLIDWORKS MBD 2022
DATE:	September 2021
SUBJECT:	MBD Package
ABSTRACT:	Guide for installing the SOLIDWORKS MBD package

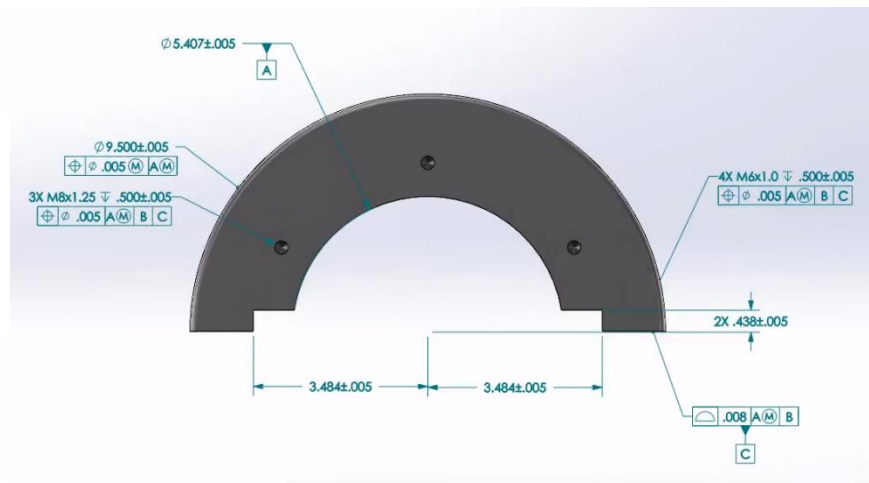

This guide is written for SOLIDWORKS MBD 2022.

Before loading any software, you should always log in with full administrative permissions and disable your anti-virus, anti-spyware, and user account controls. The installation process has a Java component; be sure your operating system has been updated with Windows Updates recently to avoid any compatibility issues with the installer.

If you want to move a license to a new system or from one machine to another, you must transfer that license beforehand. See the [license agreement](#) if you are unsure about this policy.

This is not a troubleshooting guide. If you have any technical issues with SOLIDWORKS MBD please contact [Hawk Ridge Systems Technical Support](#).

This document is only to be distributed and used by Hawk Ridge Systems customers. Any other use is prohibited.

## Contents

Before Installation.....	2
Basic Installation.....	2

## Before Installation















Hawk Ridge Systems highly recommends taking a moment before installing SOLIDWORKS and checking that you are ready to load your new software.

First, check these links to ensure minimum [system requirements](#) and the [video card](#) compatibility is met. Also, confirm that the hard drive has enough storage to have at least 15% free space, after the full installation. Back-up data such as any shared Toolbox library, Design Library, Template files, or a data management vault. As always, verify workmates, customers, or vendors are all on the same version of SOLIDWORKS. Older versions of SOLIDWORKS cannot open files from newer versions.

## Basic Installation

1. Make sure you are logged in as the administrator.
2. Disable all anti-virus and anti-spyware tools.
3. Update to SOLIDWORKS 2022 or download SOLIDWORKS 2022 from the SOLIDWORKS Customer Portal site. Once the file has been downloaded, be sure to right-click the file, select "Properties," and if there is an "unblock" option, select it and click "apply". Double-click the executable (sldIM.exe or setup.exe file) to begin the installation.

[Find our downloads and updates guide here](#)

 lang	7/22/2021 2:12 PM	File folder	
 swHelpViewer	7/22/2021 2:12 PM	File folder	
 regval.exe	11/13/2018 2:07 PM	Application	84 KB
 sldadminoptioneditor.exe	7/13/2021 6:55 PM	Application	10,802 KB
 sldBgDwld.exe	7/13/2021 6:56 PM	Application	5,689 KB
 sldIM.exe 	7/13/2021 6:56 PM	Application	25,077 KB
 sldim.xml	7/14/2021 12:40 AM	XML Document	282 KB
 sldIMDownloader.exe	7/13/2021 6:56 PM	Application	5,312 KB
 sldps.dll	7/13/2021 6:56 PM	Application extens...	3,511 KB
 sldps_libFNP.dll	7/13/2021 6:56 PM	Application extens...	7,578 KB
 startswinstall.exe	7/13/2021 6:56 PM	Application	1,940 KB
 startswinstallhelper.exe	7/13/2021 6:56 PM	Application	299 KB
 xceedzip.dll	7/13/2021 4:11 PM	Application extens...	623 KB



4. Once started, the executable should bring you to the install wizard. Click "Install on this computer" and then click "Next".

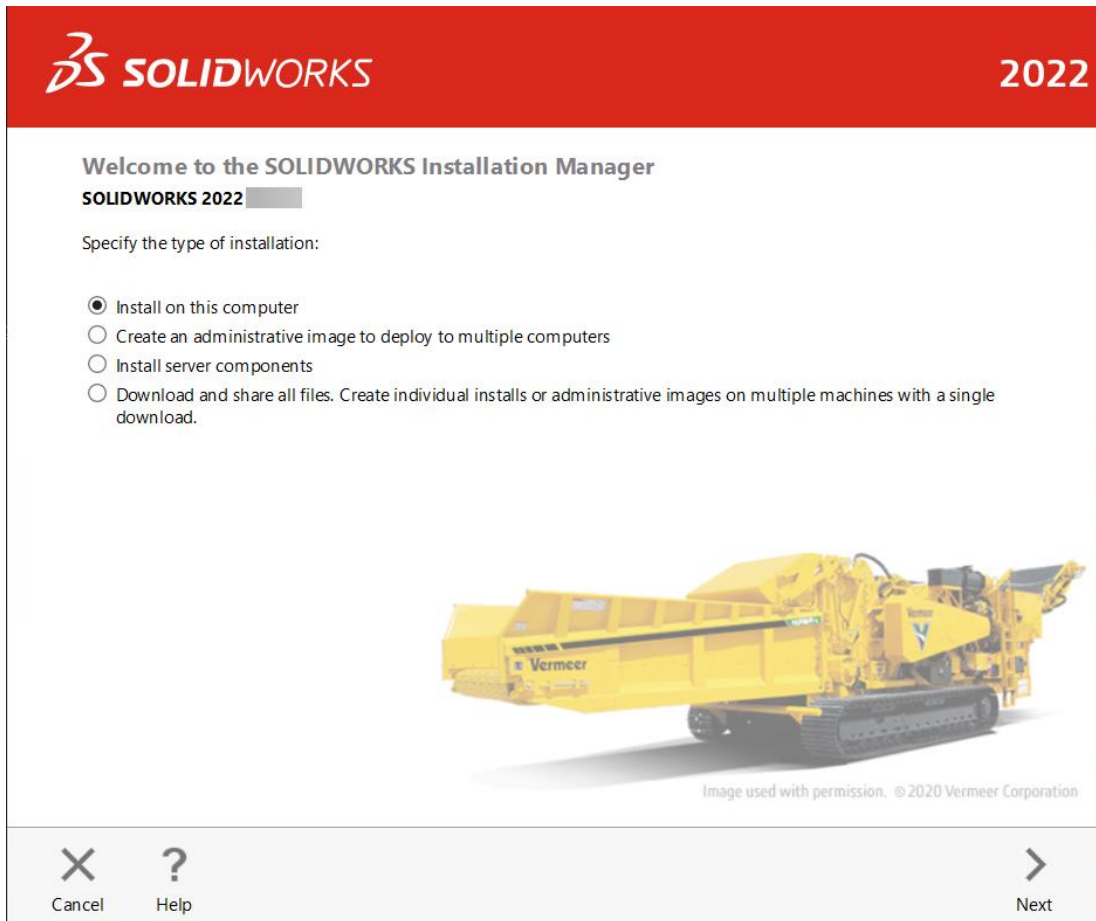



5. The next page will ask for your 24 digit serial number. If you have this information in a document, you can copy and paste this information into the first cell and it will fill out correctly. Click "Next" to continue.

6. If you already have a previous version of SOLIDWORKS installed, the next page will ask if you are upgrading or installing another installation. Select the option that best suits your needs and click "next".
7. Note that SOLIDWORKS MBD does not show up as a selection in the product selection page of the installation process because the MBD components are automatically installed with the SOLIDWORKS installer.
8. On the following page, you can set the install folder by clicking "Change". If the default (C:\Program Files) is acceptable, simply hit "Install Now" or "Download and Install".

9. Once the install is complete, click finish.
10. Launch SOLIDWORKS. You will be prompted to activate the SOLIDWORKS products. Select SOLIDWORKS MBD and click "Next".

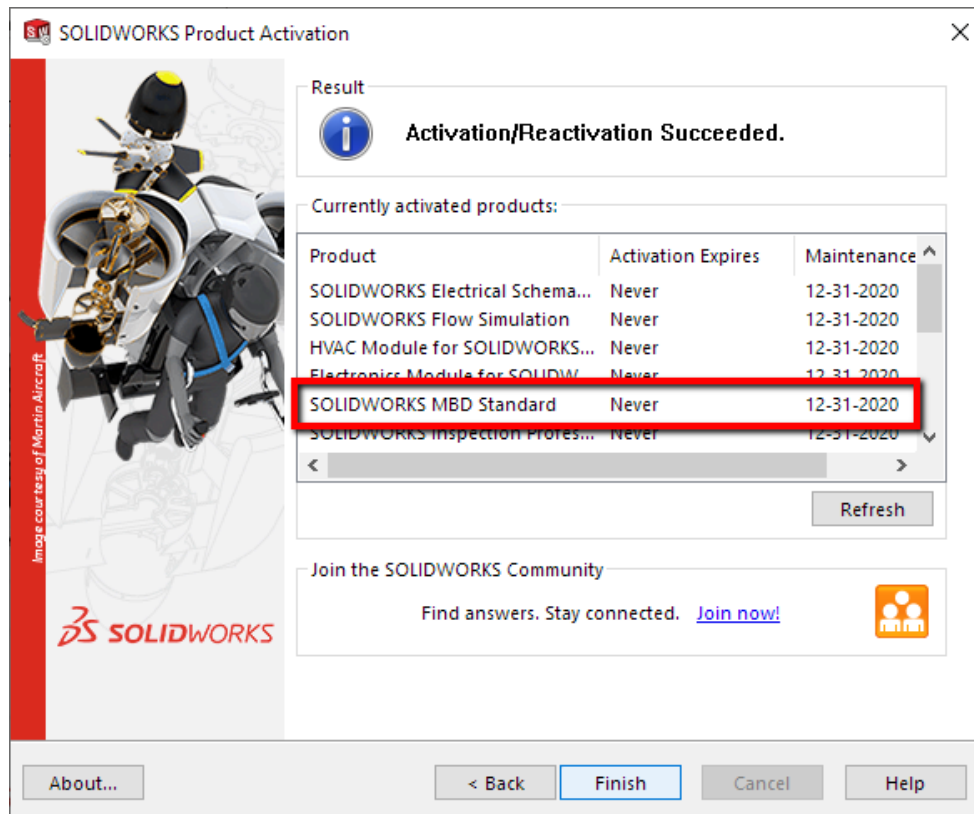

11. SOLIDWORKS MBD is not included in the SOLIDWORKS add-ins list. To use MBD, simply activate the MBD toolbar ribbon to gain access to the MBD commands.